



PUMA AW560/660

PUMA VAW700/800

Aluminum Wheel Turns



2-axis aluminum wheel turning

Superb customized horizontal aluminum wheel turning centers are designed for high precision and faster machining across a board range of aluminum wheels and to meet demanding specs for higher productivity.

PUMA AW560/660



4-axis aluminum wheel turning

Specialized aluminum wheel turning centers, PUMA VAW series redouble the machining productivity with its twin turrets, robust and systemized design construction.

PUMA VAW700/800



PUMA AW Series Main Spindle

PUMA AW560/660 Main Spindle



Max. spindle speed
3000 (2000)^{*1} r/min

Motor(30 min)
37 kW

^{*1}: PUMA AW660 & PUMA AW560 opt.

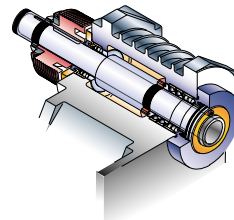

The powerful high-torque spindle motor provides power for heavy stock removal, greatly reducing the number of roughing passes required.

Main Spindle Power-torque diagram

PUMA AW560 (Max. 3000 r/min)

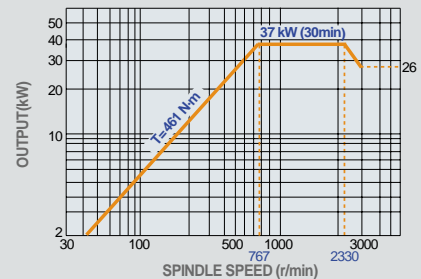

PUMA AW660 (Max. 2000 r/min)

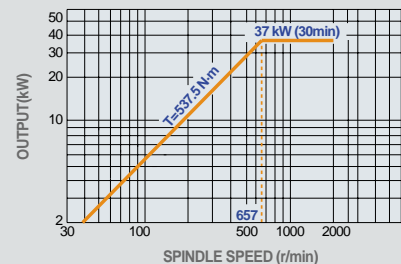

AL. Wheel Turning Capacity



PUMA AW560 X-axis travel
20 (24)^{*2} 362 mm

PUMA AW660 Z-axis travel
24 (26)^{*2} 720 mm

^{**}: The detail specifications should be reviewed before contract.

Rapid Traverse



X-axis travel
16 m/min

Z-axis travel
20 m/min

- Perfect realization of servo driven feed system

Turret



No. of tool station
12 station

Index time
 (1-station swiveled)
0.25 s

Fast indexing turret (indexing time:0.25second) designed for high productivity and take on all kinds of Aluminum Wheels.

Suitable For Al. Wheel Machining

High speed & high accuracy cutting



Doosan Al. wheel turn series finish aluminum wheels with improved efficiency, which is guaranteed by up 3000 r/min spindle speed and 0.002mm repeatability.

Shower coolant system (Opt.)



The large volume of pressure coolant system is effectively to remove heat from the aluminum wheel and tool to assure consistent high precision.

Easy chip removal

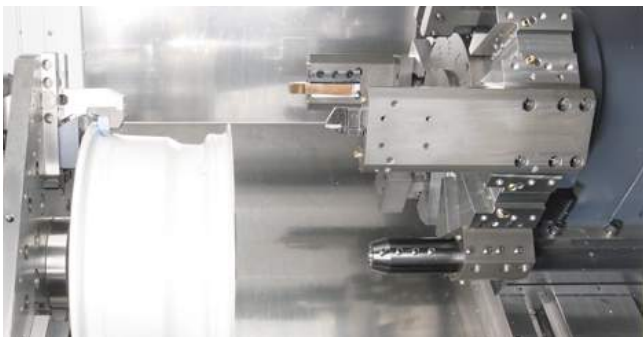

Mass of chips falls directly onto single-sheet saddle cover below for much more effective handling.

Coolant system



Large-capacity chip flushing coolant system

Machining Example

1st Operation

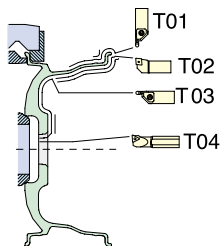

Operating Specifications

Tool No.	Shape	Tools	Cutting conditions			
		Holders (Inserts)	N(r/min)	V(m/min)	T(mm)	F(min/rev)
T01		RF151. 42-2525-60 (N151. 4-800-60-AL)	2200	2620-2618	3	0.3
T02		PCLNR 2525 M12 (CNMG 120412/kW10)	2200	2608-2042	3	0.3
T03		RF151. 42-2525-60 (N151. 4-800-60-AL)	2200	2042-440	3	0.27
T04		S25T-STFCR/16 (TCGX 16T308-AL)	2200	440-408	3	0.3

2nd Operation

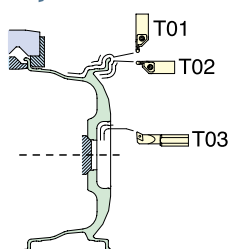

Operating Specifications

Tool No.	Shape	Tools	Cutting conditions			
		Holders (Inserts)	N (r/min)	V (m/min)	T (mm)	F (min/rev)
T01		RF151. 42-2525-60 (N151. 4-800-60-AL)	2200	2620-2618	3	0.3
T02		RF151. 42-2525-60 (N151. 4-800-60-AL)	2200	2608-2262	3	0.15
T03		S25T-SDUCR 11-M (DCGX-11T308-AL)	2200	943-408	3	0.3

PUMA VAW Series Main Spindle

PUMA VAW700/800 Main Spindle



Max. spindle speed

2000 r/min

Motor (30 min)

55 kW (opt : 75 kW)

The high-torque spindle motor provides power for heavy stock removal, greatly reducing the number of roughing passes required.

Main Spindle Power-torque diagram

PUMA VAW700/800 (Max. 3000 r/min)

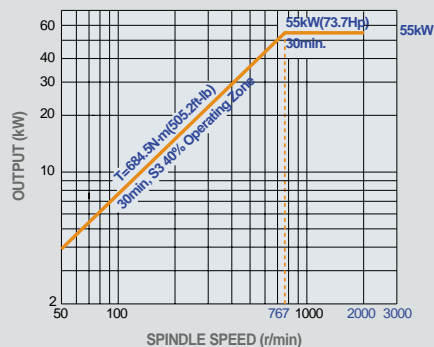

AL. Wheel Turning Capacity



PUMA VAW700

26.5 (without ACC)

PUMA VAW800

28 (without ACC)

X-axis travel

Left **570** mm

Right **570** mm

Z-axis travel

Left **550 (650)*1** mm

Right **550 (650)** mm

① 1: on VAW800

Rapid Traverse



X-axis travel

16 m/min

Z-axis travel

16 m/min

Turret



No. of tool station

6 + 6 station

Index time
(1-station swiveled)

0.15 s

High Productivity Dual Turret

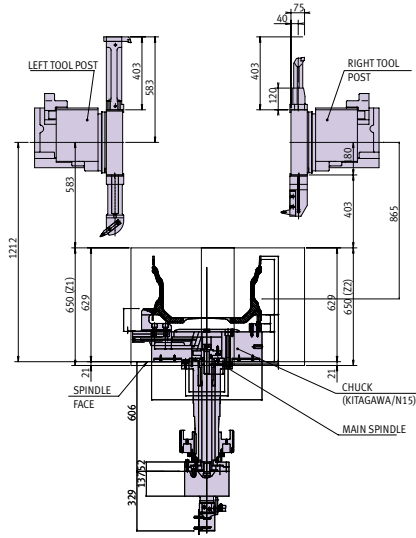

Operator's Panel



The operator panel is mounted on an adjustable pendant for easy viewing and accessibility during set-up and operation. The layout and location of the panel is ergonomically designed to maximize the efficiency of use and operator's convenience. Comprehensive alarm diagnostics are provided for the machine, control and programming errors.

AL. Wheel System Application

Doosan Infracore cell manufacturing system for aluminum wheel with a wide variety of systems containing a broad range of flexibility and automation.

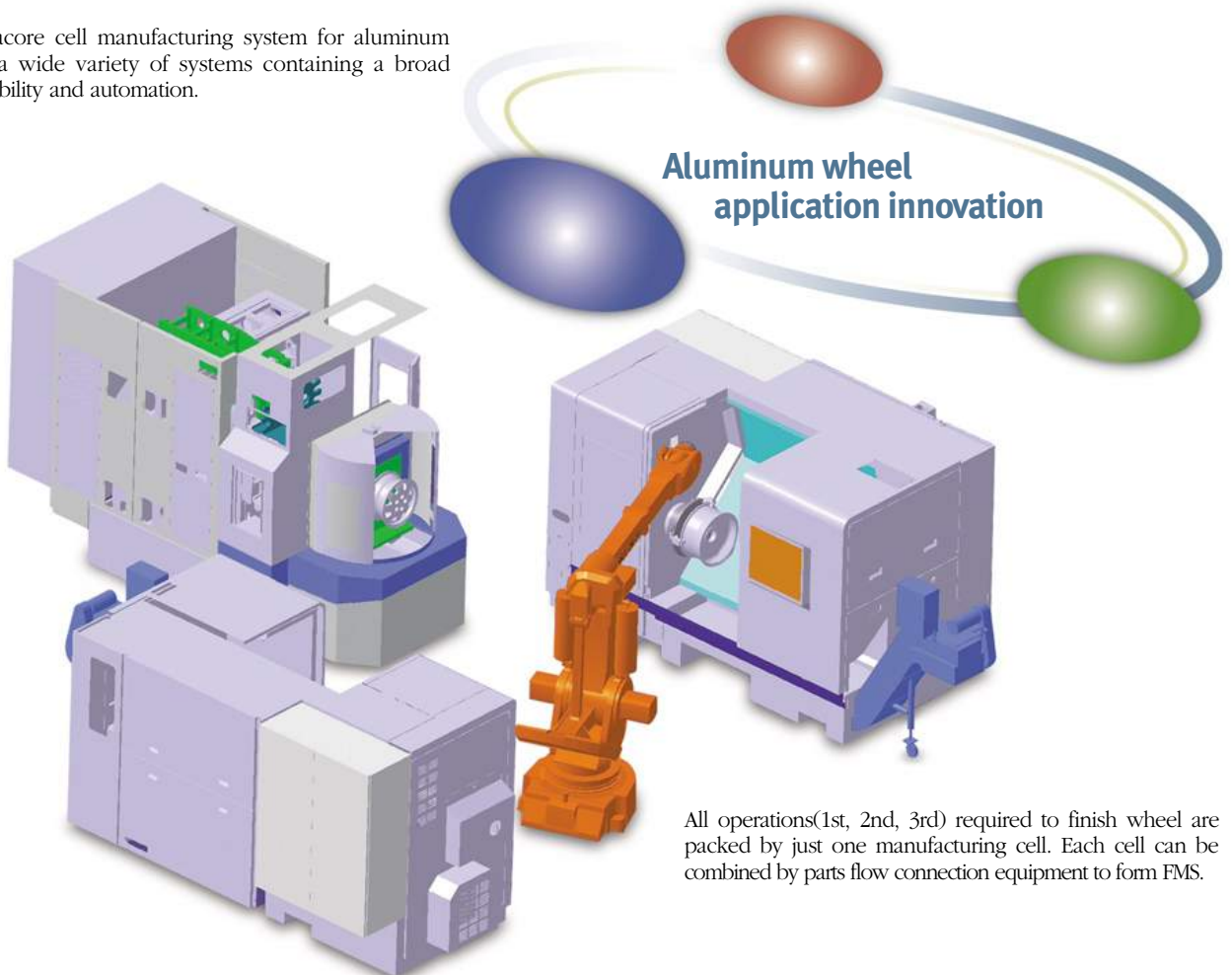

All operations(1st, 2nd, 3rd) required to finish wheel are packed by just one manufacturing cell. Each cell can be combined by parts flow connection equipment to form FMS.

Working Ranges

unit : mm

PUMA AW560

OD tool holder

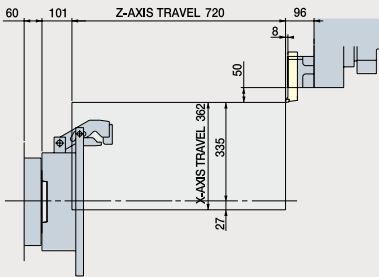

ID tool holder

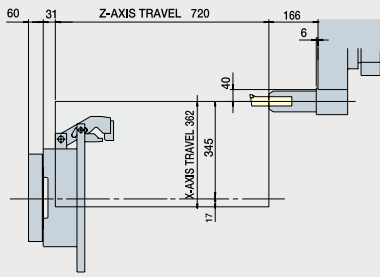

Face tool holder

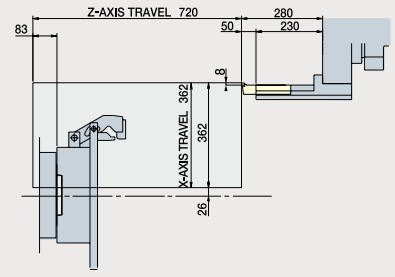

PUMA AW660

OD tool holder

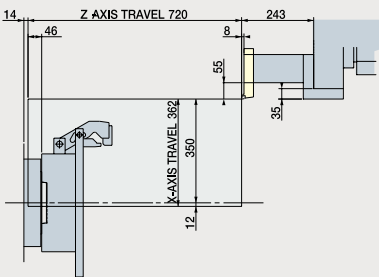

ID tool holder

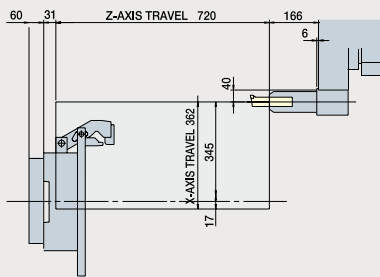

Face tool holder

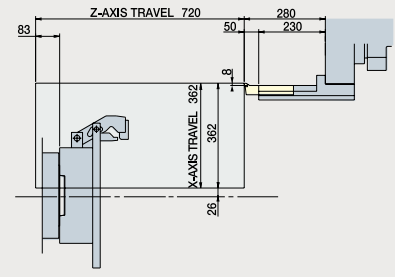

Note) Detail information of VAW700/800 does not included in the catalogue.
If the detail information related VAW700/800 needed, please contact your counterpart before contract.

Tooling System

unit : mm

PUMA AW560/660

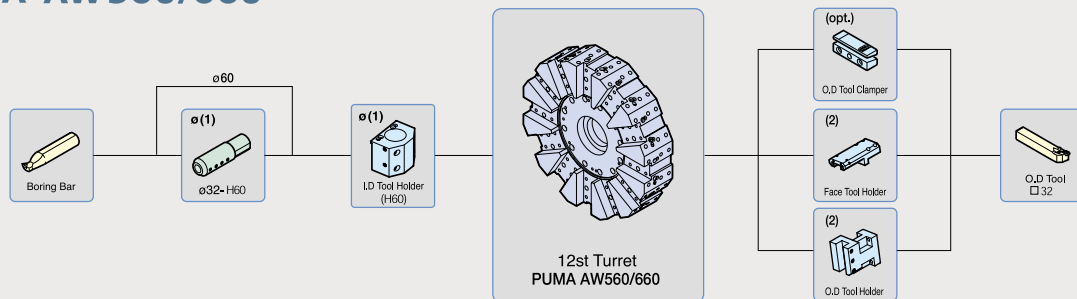

PUMA VAW 700/800

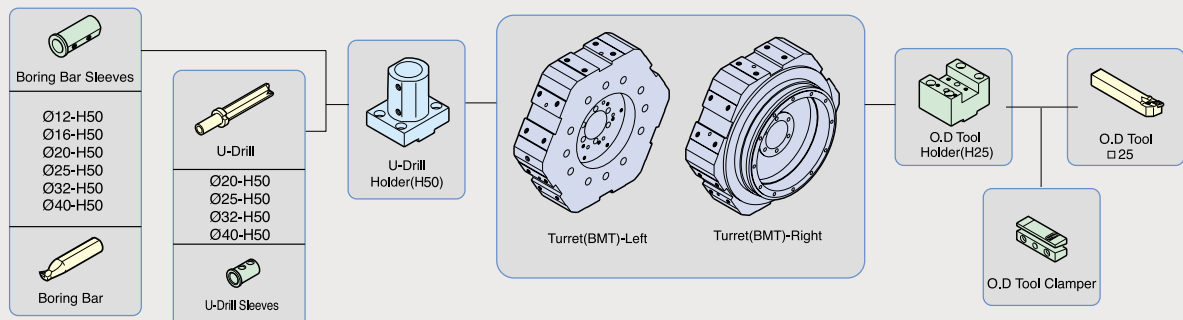

Tool Interference Diagram

unit : mm

PUMA AW560

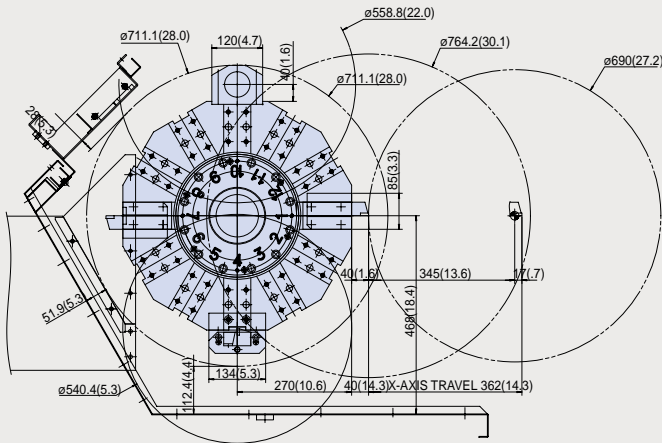

PUMA AW660

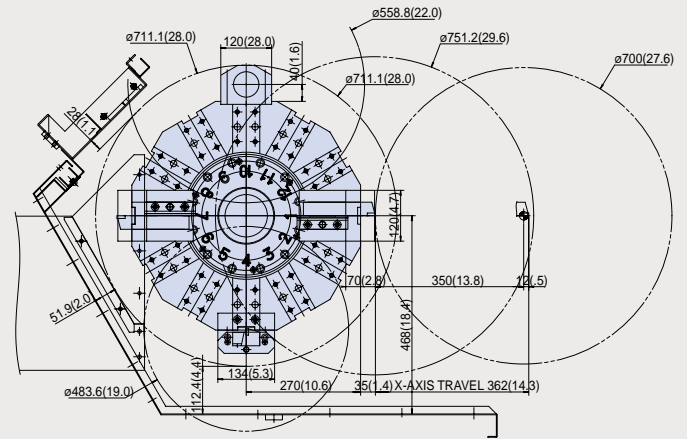

External Dimension

unit : mm

PUMA AW560/660

Top View

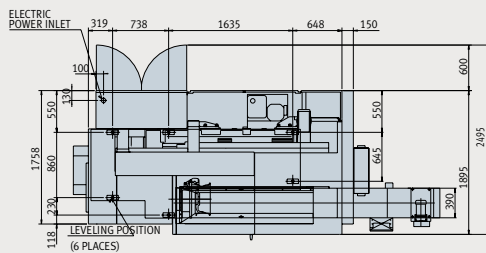

front View

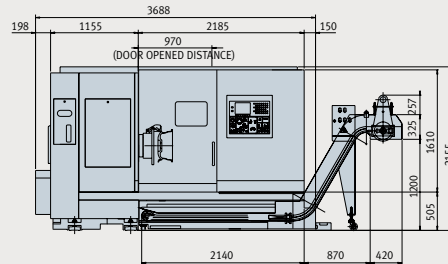

Side View

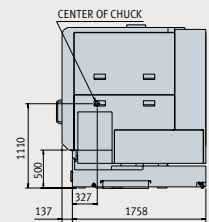

PUMA VAW 700

Top View

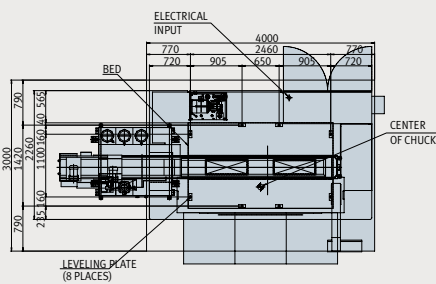

front View

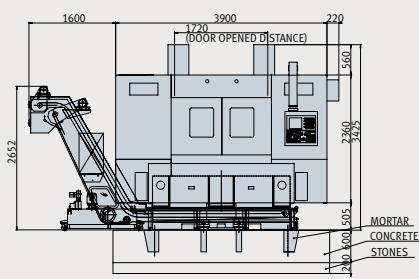

Side View

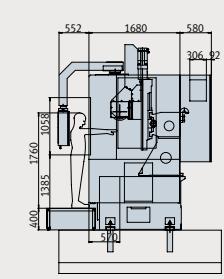

PUMA VAW 800

Top View

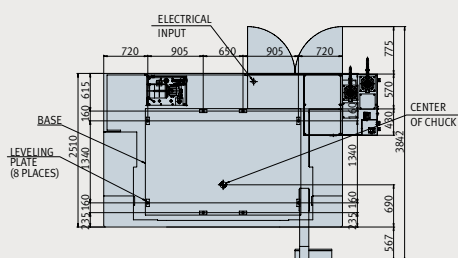

front View

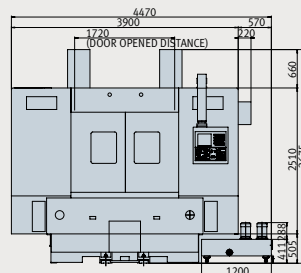

Side View

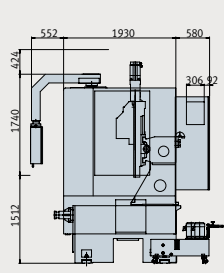

Machine Specifications

Item			PUMA AW560	PUMA AW560MF*	PUMA AW660	PUMA VAW700	PUMA VAW800
Capacity	Swing over bed	mm	830			900	1140
	Swing over saddle	mm	600			730	970
	Max. turning diameter	mm	550		650	673	711
	Max. turning length	mm	710			330	440
	Recom, wheel size	inch	20 {24 }	20	24 {26 }	26.5	28
Carriage	Travel distance X-axis	mm	362			570	
	Z-axis	mm	720			550	650
Main Spindle	Spindle speed	r/min	3000	2500	2000	2000	
	Spindle nose	ASA	A2 #8			A2 #11	
	Spindle bearing diameter (Front)	mm	160	130	180	150 {180}	
Tool Post	No. of tool station		12st			6st + 6st	
	OD tool height	mm	32 x 32			25 x 25	
	Boring bar diameter	mm	ø60			ø50	
	Indexing time (1st swivel)	s	0.25			0.15	
Feedrate	Rapid traverse X-axis	m/min	16				
	Z-axis	m/min	20			16	
	Max. cutting feedrate X-axis	mm/rev	500				
	Z-axis	mm/rev	500				
ACC	Automatic chuck changer (A.C.C)		-			N/A	
Motors	Main spindle motor	kW	30/37	25/30	30/37	45/55	
	Servo motor X-axis	kW	4.0				
	Z-axis	kW	7.0			4.0	
	Coolant pump	kW	1.5				
Power Source	Electric power supply (Rated capacity)	kVA	53.1			88.2	
Machine Size	Machine height	mm	2155			3425	3675
	Machine Demension length	mm	3688			4470	
	width	mm	2495			3602	3842
	Machine weight	kg	7750		8000	13000	13500
NC System		Doosan Fanuc i series			Fanuc 31i-A		

Note : { } are optional. * : Mirror Finished

Standard Feature

Air blower* ¹	Full enclosure chip and coolant shield	Linear position transducer for chuck clamp detection at loading station* ²
Air gun* ¹	Hand tool kit, including small hand tool for operations	Lubrication equipment
Automatic door* ¹	Hydraulic actuating cylinder	Safety precaution name plates
Coolant supply equipment	Hydraulic power unit for operations	Standard tooling kit (tool holders & boring sleeve)
Electric power transformer	Instruction manuals & parts book	Work light
Foot switch-chuck	Levelling jack screw & plates	
Front door interlock		

*¹ : VAW700/800

Optional Feature

Additional tool holders & sleeves	Chip bucket	Safety edge sensor for auto-door
Air blast for chuck jaw or work cleaning	Chip conveyor	Semi-dry coolant
Air conditioner for electric power cabinet	Linear scale for left & right X-axis* ¹	Signal tower (yellow, red, green)
Air finger chucks	Oil mist collector	Special chucks and cylinders
Air gun	Oil skimmer	
Automatic front door with safety device	Pressure switch for chucking	
Automatic loading & unloading equipment	pressure check	

- in alphabetic order

- Design and specifications are subject to change without prior notice.
- Doosan is not responsible for difference between the information in the catalogue and the actual machine.

*¹ : VAW700/800

NC Specifications

	Item	Spec.	DOOSAN Fanuc i series	Fanuc 31i-A
Controls	Controlled axes		X, Z	X1, Z1, X2, Z2
	Simultaneously controlled axes	Std. 2 axes	2 axes	4axes
Axis Functions	Backlash compensation	0~ ± 9999 pulses		
	Follow-up / Chamfering on/off			
	HRV2 control			
	Increment system 1/10	0.0001mm / 0.00001		Opt.
	Least input increment	0.001mm / 0.0001		
	Stored stroke check1	Overtravel control		
Operation	Automatic operation(memory) / Buffer register			
	Handle incremental feed	X1, X10, X100		
	Search function	Sequence NO. / Program NO.		
Interpolation	1st, 2nd reference position check / return	G27 / G28, - / G30		
	Circular interpolation	G02		
	Continuous thread cutting			
	Dwell	G04		
	Linear interpolation	G01		
	Multiple threading / Thread cutting retract			
	Thread cutting / Synchronous cutting			
Feed Functions	Feed per minute / Feed per revolution			
	Feedrate override	0 - 200 % (10% unit)		
	Jog feed override	0 - 2000 mm/min		
	Rapid traverse override	F0/ 25 / 100 %		
Auxiliary & Spindle Functions	Spindle orientation			
	Constant surface speed control			
	M-function	M3 digit		
	S-function	S4/S5 digits		
	Spindle speed override	0~150 %		
Programming Functions	Absolute / Incremental programming			
	Canned cycle for drilling / Turning			
	Custom macro			
	Decimal point programming /pocket calculator type decimal point programming			
	Direct drawing dimension programming			
	Maximum program dimension	± 9 digits		
	Multi repetitive canned cycle	G70~G76		
	Multi repetitive canned cycle 2			
	Optional block skip	Total 9		
	Program number / Sequence number	O4 digits / N8 digits		
	Programmable data input	G10		
	Sub program call		4	10
	Tape format for FANUC series 10/11			-
	Tape format for FANUC series 15		-	
	Work coordinate system selection	G52~G59		
Tool Functions	Auto tool offset			
	Tool monitoring system		Opt.	Opt.
	Direct input of tool offset value measured B			
	Tool geometry / wear compensation	Geometry & wear data		
	Tool life management			
	Tool nose radius compensation			
	T-code function	T2+2 digits		
Tool offset pairs		64 pairs	64 pairs	
Tool offset value counter input		-		
Editing Op. Functions	Background editing			
	Expanded part program editing	Copy, Move, Change of NC program		
	No. of Registered programs		400 ea	500 ea
	Part program editing / Program protect			
Part program storage size*1		1280 m	640 m	
Setting & Display	Display of spindle speed and T-code at all screen			
	Help function	Alarm&Operation display		
	Self diagnostic function			
	Servo setting screen / Spindle setting screen			
	Tool path graphic display			
Data Input & Output	I/O interface	RS-232C		
	Memory card input and output			
	Reader puncher control	CH1 interface		
Other Functions	Ethernet function	Embedded ethernet function		
	MDI / Display unit		10.4 Color TFT LCD	10.4 Color TFT LCD
	PMC system			

*1 : Standard Part program length is different on export condition. On the addition of optional functions, its length can be reduced.

Fanuc 31i-A : PUMA VAW700/800

PUMA AW / VAW

<http://www.doosaninfracore.com/machinetools>

Sales & Support Network

ARGENTINA/Rosario **AUSTRALIA**/Melbourne/Sydney **AUSTRIA**/Vienna **BELGIUM**/Gullegem **BRAZIL**/Sao paulo **BULGARIA**/Sofia **CANADA**/Edmonton/Montreal/Toronto/Vancouver
CHILE/Santiago **CHINA**/Beijing/Chongqing/Guangzhou/Shanghai/Shenyang **COLOMBIA**/Bogota **CZECH**/Brno **DENMARK**/Randers **EGYPT**/Cairo **FINLAND**/Tampere **FRANCE**/Annecy
GERMANY/Dusseldorf **GREECE**/Athens **HONG KONG**/Kowloon **HUNGARY**/Budapest **INDIA**/Bangalore/Pune **INDONESIA**/Jakarta **IRAN**/Tehran **ISRAEL**/Herzlia **ITALY**/Parma
MALAYSIA/Kuala Lumpur/Penang/Johor Bahru **MEXICO**/Guadalajara /Mexico City /Monterrey /Vera Cruz **NETHERLANDS**/Goorn **NEW ZEALAND**/Auckland **NORWAY**/Oslo **PAKISTAN**
/Islamabad/Karachi/Lahore **PHILIPPINES**/Manila **POLAND**/Krakow **PORTUGAL**/Lisbon **ROMANIA**/Bucharest **RUSSIA**/Moscow **SAUDI ARABIA**/Riyadh **SINGAPORE**/Singapore
SLOVENIA/Ljubljana **SOUTH AFRICA**/Kempton Park **SPAIN**/Barcelona **SWEDEN**/Stockholm **SWITZERLAND**/Zurich **TURKEY**/Istanbul **THAILAND**/Bangkok **U.A.E**/Sharjah
U. K./Leamington **U.S.A.**/Atlanta/Birmingham/Charlotte/Chicago/Cincinnati/Cleveland/Dallas/Denver/Detroit/Houston/Indianapolis/Kansas City/Little Rock/Los Angeles/Milwaukee/Minneapolis
/New Orleans/Norfolk/Philadelphia/Phoenix/Pittsburgh/Portland/Rochester/Salt Lake City/San Diego/San Francisco/Seattle/Springfield/St. Louis/Tampa/Trenton/Tulsa **VENEZUELA**/Valencia
VIETNAM/Hanoi/Ho Chi Minh City



Doosan Infracore
Machine Tools

Head Office : Doosan Tower 20th FL., 18-12, Euljiro-6Ga, Jung-Gu, Seoul, Korea 100-730
Tel : ++82-2-3398-8693 / 8671 / 8680 Fax : ++82-2-3398-8699

Doosan Infracore America Corp.: 19A Chapin Rd. Pine Brook, NJ 07058, U.S.A.
Tel : ++1-973-618-2500 Fax : ++1-973-618-2501

Doosan Infracore Germany GmbH : Emdener Strasse 24, D-41540 Dormagen, Germany.
Tel : ++49-2133-5067-100 Fax : ++49-2133-5067-001

Doosan Infracore Yantai Co., LTD : 13 Building, 140 Tianlin Road, Xuhui District, Shanghai, China (200233)
Tel : ++86-21-6440-3384 (808, 805) Fax : ++86-21-6440-3389

